



- ans

Certifié selon la Norme Européenne EN 1176 par l'institut polonais INT



Hauteur de chute
90 cm



Dimensions
Ø 200 cm



Espace minimum
Ø 550 cm



Zone d'impact
31 m²



Structure en acier.

PLAN

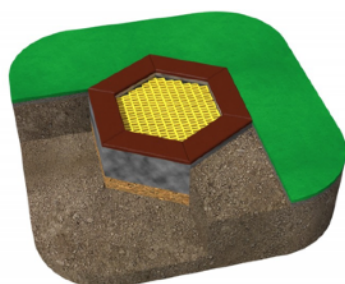
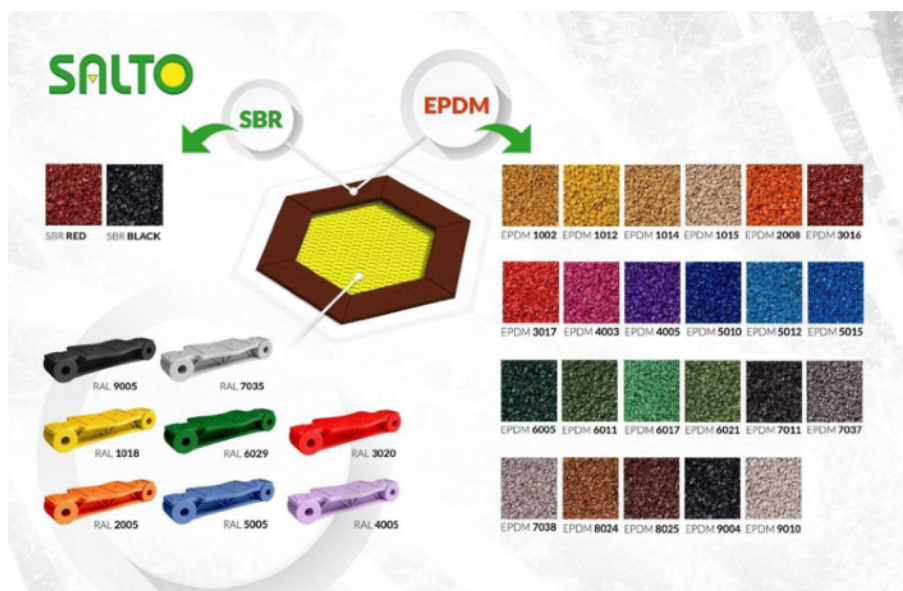
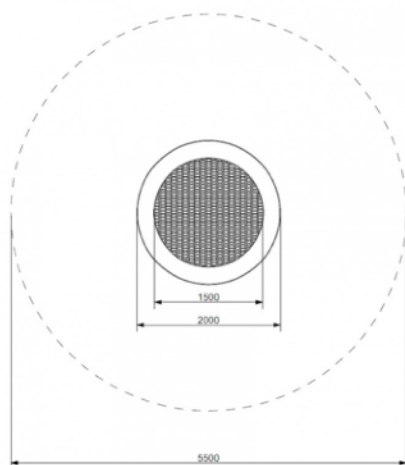

INFORMATIONS PRODUIT

- **Garantie:**
- 10 ans pour la structure en inox
- 5 ans pour: parties métalliques, parties aluminium, polyéthylène
- 2 ans pour: cordes, clips, connecteurs, revêtements peints
- 1 an pour: roulements, ressorts, pièces de fixations pour balançoire