



- ans

Certifié selon la Norme Européenne EN 1176 par l'institut polonais INT



Hauteur de chute  
**90 cm**



Dimensions  
**Ø 175 cm**



Espace minimum  
**Ø 425 cm**



Zone d'impact  
**19 m<sup>2</sup>**



Structure en acier.

### PLAN

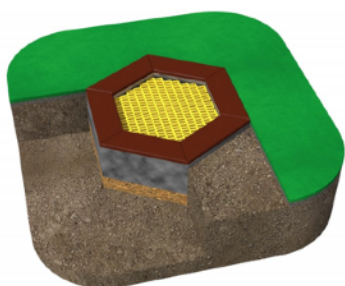
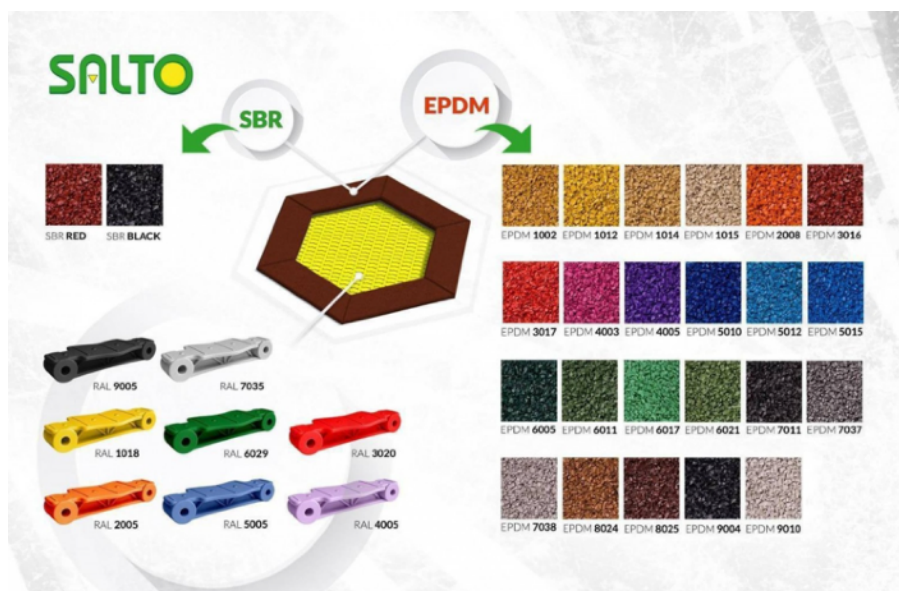
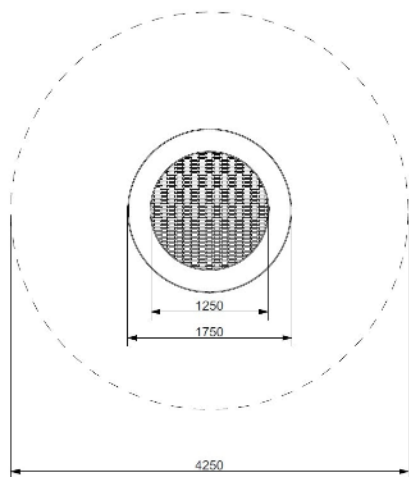

### INFORMATIONS PRODUIT

- **Garantie:**
- 10 ans pour la structure en inox
- 5 ans pour: parties métalliques, parties aluminium, polyéthylène
- 2 ans pour: cordes, clips, connecteurs, revêtements peints
- 1 an pour: roulements, ressorts, pièces de fixations pour balançoire